

Tectite

Price list – 1st March 2010

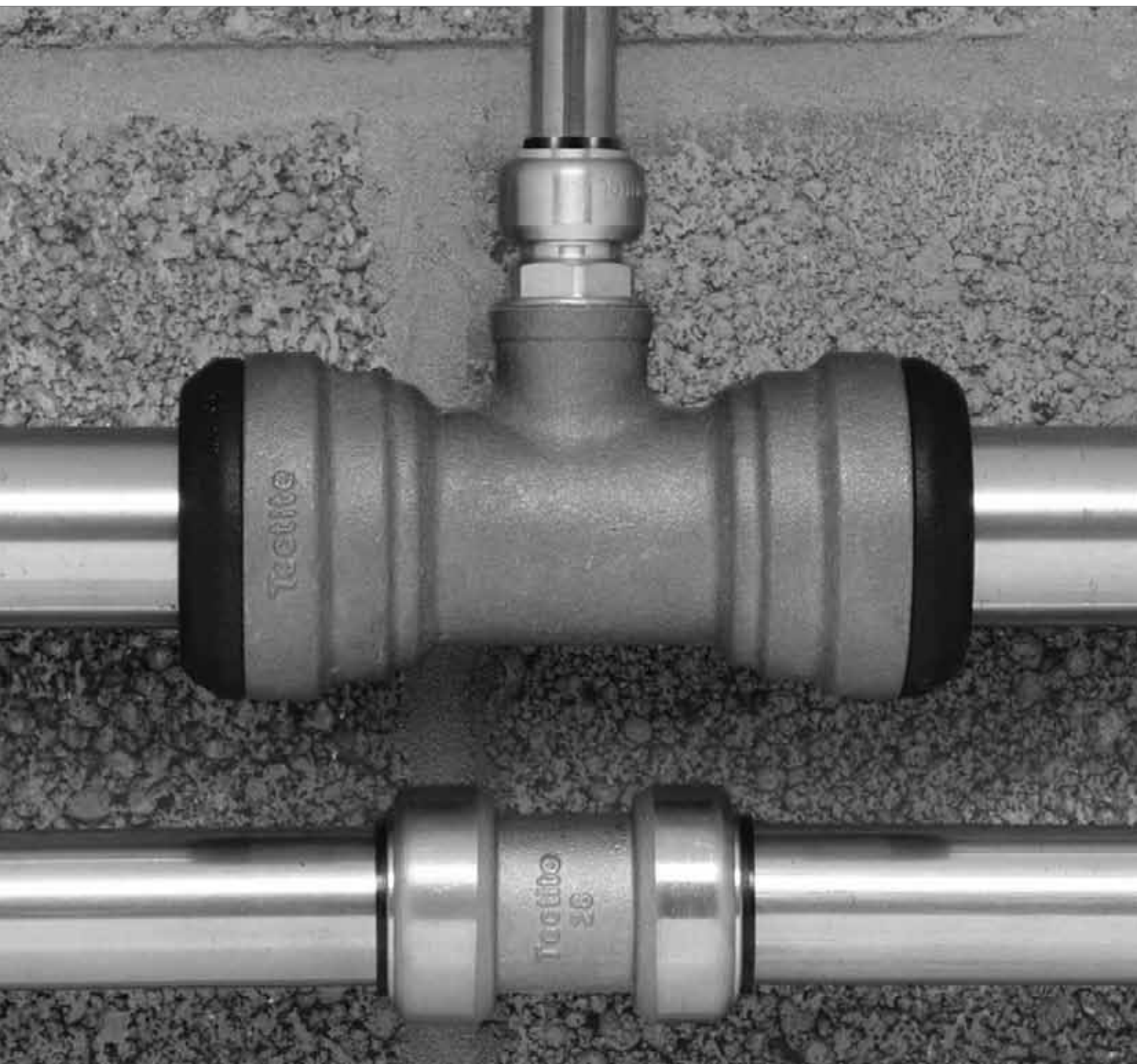

Push-fit solutions

<i>Tectite System PEX Pipe</i>	3
<i>Tectite Sprint push-fit fittings</i>	3-4
<i>Tectite Classic push-fit fittings</i>	4-6
<i>Tectite Classic Flexifit</i>	6
<i>Tectite Classic push-fit manifolds</i>	6
<i>Tectite Pro push-fit fittings</i>	6-8
<i>Tectite Pro Flexifit</i>	8
<i>Tectite 316 System Tube</i>	8
<i>Tectite 316 push-fit fittings</i>	8-9
<i>Carbon Steel System Tube</i>	9
<i>Tectite Advance push-fit fittings</i>	10-11
<i>Tectite accessories</i>	11-12
<i>Tectite Pro Valves</i>	12





Tectite System PEX Pipe

TP520 Barrier pipe Straight lengths

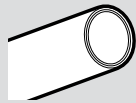

SIZE	CODE	£ MTR
15mm x 3m	60029	1.58
15mm x 6m	60030	1.58
22mm x 3m	60037	3.15
22mm x 6m	60038	3.15
28mm x 3m	60041	5.21
28mm x 6m	60042	5.21

TP525 Barrier pipe Coil

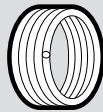

SIZE	BOX QTY	CODE	£ MTR
12mm x 50m	50	60020	1.27
12mm x 100m	100	60021	1.27
15mm x 25m	25	60024	1.73
15mm x 50m	50	60025	1.58
15mm x 100m	100	60026	1.58
22mm x 25m	25	60033	3.45
22mm x 50m	50	60034	3.15

Tectite Sprint push-fit fittings

TT1/TT270 Straight coupling push-fit x push-fit

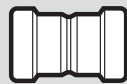

SIZE	BOX QTY	CODE	£ EACH
10mm	10	75500	1.90
15mm	10	75501	1.47
18mm	5	75663	1.94
22mm	5	75502	2.18
28mm	5	75503	5.22

TT1R/TT240 Reducing coupling push-fit x push-fit

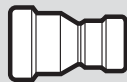

SIZE	BOX QTY	CODE	£ EACH
15 x 10mm	10	75504	3.10
18 x 15mm	5	75668	3.42
22 x 15mm	5	75505	3.64
22 x 18mm	5	75671	4.05

TT2/TT270G Straight female connector push-fit x BSP parallel female thread

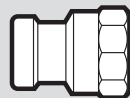

SIZE	BOX QTY	CODE	£ EACH
10mm x 1/2"	10	75672	3.84
15mm x 1/2"	10	75510	2.01
18mm x 1/2"	5	75677	4.09
18mm x 3/4"	5	75835	2.66
22mm x 3/4"	5	75511	3.05
28mm x 1"	2	75678	7.83

Tectite Sprint push-fit fittings (contd)

TT3/TT243G Straight male connector push-fit x BSP taper male thread

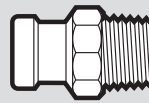

SIZE	BOX QTY	CODE	£ EACH
15mm x 1/2"	10	75515	2.26
18mm x 3/4"	5	75687	5.11
22mm x 3/4"	5	75516	5.33
28mm x 1"	2	75518	7.17

TT5 Tank connector push-fit x BSP parallel male thread with backnut

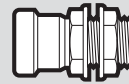

SIZE	BOX QTY	CODE	£ EACH
15mm x 1/2"	5	75520	3.37
22mm x 3/4"	5	75521	4.28

TT6/TT243 Reducer larger end male for insertion into fitting x push-fit

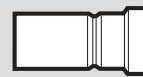

SIZE	BOX QTY	CODE	£ EACH
15 x 10mm	10	75523	1.51
22 x 15mm	5	75525	1.95
28 x 15mm	5	75526	3.81
28 x 22mm	5	75527	4.14

TT12/TT090 Elbow push-fit x push-fit

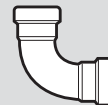

SIZE	BOX QTY	CODE	£ EACH
10mm	10	75530	2.17
15mm	10	75531	1.81
18mm	5	75692	2.37
22mm	5	75532	2.62
28mm	5	75533	6.08

TT12S/TT092 Street elbow push-fit x male end for insertion into fitting



SIZE	BOX QTY	CODE	£ EACH
10mm	10	75535	2.53
10 x 15mm	10	75536	2.88
18mm	5	75696	2.66
15mm	10	75537	1.97
22mm	5	75538	3.02

TT13/TT092G Male elbow push-fit x BSP taper male thread



SIZE	BOX QTY	CODE	£ EACH
15mm x 1/2"	10	75540	3.11
18mm x 1/2"	5	75832	4.51
22mm x 3/4"	5	75833	4.66

TT14/TT090G Female elbow push-fit x BSP parallel female thread



SIZE	BOX QTY	CODE	£ EACH
15mm x 1/2"	10	75545	3.54
18mm x 1/2"	5	75830	4.70
22mm x 3/4"	5	75831	5.26

TT15/TT471G Backplate elbow push-fit x BSP parallel female thread

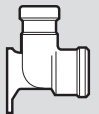

SIZE	BOX QTY	CODE	£ EACH
15mm x 1/2"	5	75550	5.33
18mm x 1/2"	5	75834	12.02

TT21/TT041 Obtuse elbow push-fit x push-fit



SIZE	BOX QTY	CODE	£ EACH
15mm	10	75551	3.07
18mm	5	75704	4.17
22mm	5	75552	4.44
28mm	5	75553	11.98

TT21S/TT040 Obtuse street elbow push-fit x male end for insertion in fitting



SIZE	BOX QTY	CODE	£ EACH
15mm	10	75585	2.62
18mm	5	75708	4.06
22mm	5	75586	3.87
28mm	5	75587	13.20

TT24/TT130 Equal tee push-fit on all ends

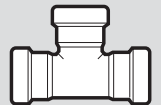

SIZE	BOX QTY	CODE	£ EACH
10mm	10	75555	2.64
15mm	10	75556	2.50
18mm	5	75712	3.30
22mm	5	75557	3.53
28mm	2	75558	8.59

TT25/TT130 Tee, reduced branch push-fit on all ends



SIZE	BOX QTY	CODE	£ EACH
15 x 15 x 10mm	10	75565	3.57
18 x 18 x 15mm	5	75719	3.61
22 x 22 x 10mm	5	75566	3.99
22 x 22 x 15mm	5	75567	3.99
22 x 22 x 18mm	5	75722	5.09
28 x 28 x 15mm	2	75568	9.47
28 x 28 x 18mm	2	75723	9.34
28 x 28 x 22mm	2	75569	9.47

TT26/TT130 Tee, one end reduced push-fit on all ends

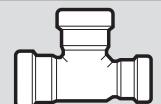

SIZE	BOX QTY	CODE	£ EACH
18 x 15 x 18mm	5	75726	3.61
22 x 15 x 22mm	5	75573	4.20
22 x 18 x 22mm	5	75727	5.09
28 x 15 x 28mm	2	75574	9.47
28 x 22 x 28mm	2	75575	9.47

**Tectite Sprint
push-fit fittings (contd)**

TT27/TT130
**Tee, one end and
branch reduced**
push-fit on all ends

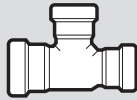

SIZE	BOX QTY	CODE	£ EACH
22 x 15 x 15mm	5	75582	3.99
22 x 18 x 18mm	5	75729	5.09
28 x 18 x 18mm	2	75730	9.34
28 x 22 x 22mm	2	75584	8.89

TT61/TT301
Stop end
push-fit end for
use on tube



SIZE	BOX QTY	CODE	£ EACH
10mm	10	75590	1.71
15mm	10	75591	1.78
18mm	5	75734	2.19
22mm	5	75592	2.26
28mm	5	75593	4.99

TT62/TT062
Tap connector
push-fit x BSP union nut

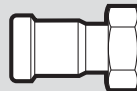

SIZE	BOX QTY	CODE	£ EACH
10mm x 1/2"	10	75600	2.67
15mm x 1/2"	10	75601	2.40
18mm x 3/4"	5	75742	2.75
22mm x 3/4"	5	75603	2.75

TT63/TT063
Bent tap connector
push-fit x BSP union nut



SIZE	BOX QTY	CODE	£ EACH
10mm x 1/2"	10	75604	3.55
15mm x 1/2"	10	75605	3.04
18mm x 1/2"	5	75744	3.55

Tectite Classic push-fit fittings

T1/T270
Straight coupling
push-fit x push-fit



SIZE	BOX QTY	CODE	£ EACH
10mm	10	45108	3.94
12mm	10	45110	4.76
15mm	10	45114	2.57
18mm	5	45118	3.87
22mm	5	45121	4.13
28mm	5	45123	8.47

Chrome plated

10mm	10	45109	8.53
12mm	10	45111	10.28
15mm	10	45115	5.57

T1R/T240
Reducing coupling
push-fit x push-fit

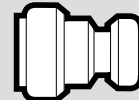

SIZE	BOX QTY	CODE	£ EACH
12 x 10mm	10	45155	8.14
15 x 10mm	10	45159	8.14
15 x 12mm	10	45161	8.14
18 x 15mm	5	45167	11.35
22 x 10mm	5	45170	11.52
22 x 15mm	5	45172	11.35
22 x 18mm	5	45174	11.35
28 x 22mm	2	45178	12.72

Chrome plated

12 x 10mm	10	45156	17.59
15 x 10mm	10	45160	17.59
15 x 12mm	10	45162	17.59

T1S/T270S
Slip coupling
push-fit x push-fit

SIZE	BOX QTY	CODE	£ EACH
15mm	10	45141	2.51
18mm	5	45142	3.78
22mm	5	45143	4.03
28mm	5	45144	8.25

T2/T270G
Straight female connector
push-fit x BSP parallel
female thread

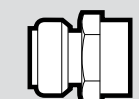

SIZE	BOX QTY	CODE	£ EACH
12mm x 3/8"	10	45194	7.28
12mm x 1/2"	10	45196	6.96
15mm x 1/2"	10	45206	5.27
15mm x 3/8"	10	45204	5.27
18mm x 1/2"	5	45210	10.95
18mm x 3/4"	5	45212	11.26
22mm x 3/4"	5	45222	5.96
22mm x 1/2"	5	45220	5.96
22mm x 1"	5	45223	7.84
28mm x 3/4"	2	45224	13.74
28mm x 1"	2	45225	13.74

Chrome plated

10mm x 3/8"	10	45191	14.59
10mm x 1/2"	10	45193	14.59
12mm x 3/8"	10	45195	15.72
12mm x 1/2"	10	45197	15.01
15mm x 3/8"	10	45205	11.38
15mm x 1/2"	10	45207	11.38

T3T/T243G
Straight male connector
push-fit x BSP taper
male thread

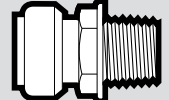

SIZE	BOX QTY	CODE	£ EACH
12mm x 3/8"	10	45254	6.96
12mm x 1/2"	10	45256	7.28
15mm x 1/2"	10	45267	3.38
15mm x 3/8"	10	45265	3.38
18mm x 1/2"	5	45286	10.59
18mm x 3/4"	5	45288	11.09
22mm x 1/2"	5	45290	7.94
22mm x 3/4"	5	45292	7.94
22mm x 1"	5	45294	8.47
28mm x 1"	2	45296	10.94

Chrome plated

10mm x 3/8"	10	45251	15.72
10mm x 1/2"	10	45253	15.72
12mm x 3/8"	10	45255	15.04
12mm x 1/2"	10	45257	15.75
15mm x 3/8"	10	45266	7.30
15mm x 1/2"	10	45268	7.30

T3P
Straight male connector
push-fit x BSP parallel
male thread

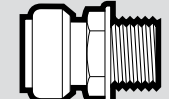

SIZE	BOX QTY	CODE	£ EACH
15mm x 1/2"	10	45358	3.38
22mm x 1/2"	5	45364	8.19
22mm x 3/4"	5	45366	7.94
22mm x 1"	5	45368	8.47
28mm x 1"	2	45370	10.94

T5
Tank connector
push-fit x BSP parallel
male thread with backnut

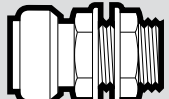

SIZE	BOX QTY	CODE	£ EACH
15mm x 1/2"	5	45390	5.96
22mm x 3/4"	5	45394	7.52
28mm x 1"	2	45396	17.72

T6/T243
Reducer
Larger end male for insertion
into fitting x push-fit

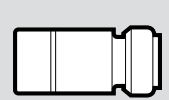

SIZE	BOX QTY	CODE	£ EACH
12 x 10mm	10	45410	5.38
15 x 10mm	10	45416	4.50
15 x 12mm	10	45418	5.65
18 x 15mm	5	45424	3.48
22 x 15mm	5	45426	3.48
22 x 18mm	5	45430	3.93
28 x 15mm	5	45435	7.72
28 x 18mm	5	45437	7.72
28 x 22mm	5	45438	6.61

Chrome plated

12 x 10mm	10	45411	11.63
15 x 10mm	10	45417	9.73
15 x 12mm	10	45419	12.19

Tectite Classic push-fit fittings (contd)

T12/T090 Elbow
push-fit x push-fit

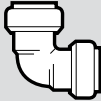

SIZE	BOX QTY	CODE	£ EACH
10mm	10	45510	5.16
12mm	10	45512	5.67
15mm	10	45516	3.01
22mm	5	45524	4.73
28mm	5	45526	11.49
Chrome plated			
10mm	10	45511	5.16
15mm	10	45517	6.39
18mm	5	45520	4.73

T12S/T092 Street elbow
push-fit x male end for insertion into fitting

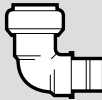

SIZE	BOX QTY	CODE	£ EACH
10mm	10	45490	4.46
10 x 15mm	10	45494	3.83
15mm	10	45496	3.22
18mm	5	45498	4.23
22mm	5	45500	4.46
28mm	5	45502	11.19

T12SNP/T092 street elbow
push-fit x male end for insertion into fitting
Nickel plated finish

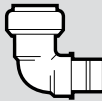

SIZE	BOX QTY	CODE	£ EACH
10mm	10	45491	7.54
10 x 15mm	10	45495	6.88
15mm	10	45497	6.88

T13/T092G Male elbow
push-fit x BSP taper male thread

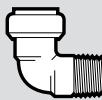

SIZE	BOX QTY	CODE	£ EACH
12mm x 3/8"	10	45554	5.34
12mm x 1/2"	10	45556	5.79
15mm x 1/2"	10	45561	4.50
18mm x 1/2"	5	45569	5.81
18mm x 3/4"	5	45570	6.45
22mm x 3/4"	5	45576	5.34
28mm x 1"	5	45578	10.04
Chrome plated			
10mm x 3/8"	10	45551	9.37
10mm x 1/2"	10	45553	9.80
12mm x 3/8"	10	45555	11.52
12mm x 1/2"	10	45557	12.51
15mm x 1/2"	10	45562	9.73

T14/T090G Female elbow
push-fit x BSP parallel female thread



SIZE	BOX QTY	CODE	£ EACH
12mm x 3/8"	10	45594	5.27
12mm x 1/2"	10	45596	5.58
15mm x 1/2"	10	45606	5.27
18mm x 1/2"	5	45614	6.85
18mm x 3/4"	5	45615	7.61
22mm x 3/4"	5	45620	7.84
28mm x 1"	2	45622	14.37
Chrome plated			
10mm x 3/8"	10	45591	11.01
10mm x 1/2"	10	45593	12.02
12mm x 3/8"	10	45595	11.38
12mm x 1/2"	10	45597	14.73
15mm x 1/2"	10	45607	11.38

T15/T471G Backplate elbow
push-fit x BSP parallel female thread

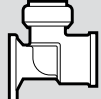

SIZE	BOX QTY	CODE	£ EACH
12mm x 1/2"	5	45638	10.16
15mm x 1/2"	5	45646	8.47
18mm x 1/2"	5	45650	11.03
18mm x 3/4"	5	45652	12.25
22mm x 3/4"	5	45654	16.77
Chrome plated			
10mm x 1/2"	5	45631	13.62
12mm x 1/2"	5	45639	21.96
15mm x 1/2"	5	45647	18.31

T21/T041 Obtuse elbow
push-fit x push-fit



SIZE	BOX QTY	CODE	£ EACH
12mm	10	45531	6.70
15mm	10	45535	3.60
18mm	5	45537	4.50
22mm	5	45538	4.67
28mm	5	45539	15.79

T21S/T040 Obtuse street elbow
push-fit x male end for insertion into fitting



SIZE	BOX QTY	CODE	£ EACH
12mm	10	45528	5.62
15mm	10	45542	3.02
18mm	5	45544	4.16
22mm	5	45545	4.23
28mm	5	45546	16.39

T24/T130 Equal tee
Push-fit on all ends

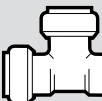

SIZE	BOX QTY	CODE	£ EACH
10mm	10	45660	6.25
12mm	10	45662	7.16
15mm	10	45666	4.50
22mm	5	45676	6.85
28mm	2	45678	14.99
Chrome plated			
10mm	10	45661	13.50
12mm	10	45663	15.44
15mm	10	45667	6.94

T25/T130 Tee, reduced branch
Push-fit on all ends

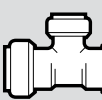

SIZE	BOX QTY	CODE	£ EACH
15 x 15 x 10mm	10	45715	6.25
15 x 15 x 12mm	10	45717	7.16
22 x 22 x 10mm	5	45730	6.25
22 x 22 x 15mm	5	45737	6.25
22 x 22 x 18mm	5	45742	7.72
28 x 28 x 15mm	2	45744	14.09
28 x 28 x 18mm	2	45745	17.47
28 x 28 x 22mm	2	45746	14.09
Chrome plated			
15 x 15 x 10mm	10	45716	13.50
15 x 15 x 12mm	10	45718	15.49

T26/T130 Tee, one end reduced
push-fit on all ends

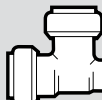

SIZE	BOX QTY	CODE	£ EACH
15 x 10 x 15mm	10	45780	6.25
22 x 15 x 22mm	5	45786	6.25
22 x 18 x 22mm	5	45788	7.72
28 x 15 x 28mm	2	45790	14.09
28 x 18 x 28mm	2	45792	17.47
28 x 22 x 28mm	2	45793	14.09

T27/T130 Tee, one end and branch reduced
Push-fit on all ends

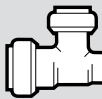

SIZE	BOX QTY	CODE	£ EACH
15 x 10 x 10mm	10	45810	6.25
22 x 15 x 15mm	5	45820	6.25
22 x 18 x 18mm	5	45819	7.72
28 x 18 x 18mm	2	45821	17.47
28 x 22 x 22mm	2	45822	14.09

T30/T130G Female branch tee
push-fit ends x BSP parallel female branch

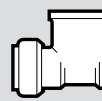

SIZE	BOX QTY	CODE	£ EACH
15 x 15mm x 1/2"	10	45840	8.65
22 x 22mm x 1/2"	5	45845	9.97
22 x 22mm x 3/4"	5	45846	11.47
Chrome plated			
15 x 15mm x 1/2"	10	45841	18.68

Tectite Classic push-fit fittings (contd)

T61/T301 Stop end
Push-fit ends for use on tube

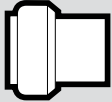

SIZE	BOX QTY	CODE	£ EACH
10mm	10	45860	4.32
12mm	10	45862	3.22
18mm	5	45870	3.25
15mm	10	45866	2.40
22mm	5	45874	3.49
28mm	5	45876	7.77

Chrome plated

10mm	10	45861	9.33
15mm	10	45867	5.17

T61RV/T302 Air release stop end
push-fit x air release valve



SIZE	BOX QTY	CODE	£ EACH
10mm	10	45890	6.61
12mm	10	45891	6.61
15mm	10	45892	4.18
18mm	5	45893	5.02
22mm	5	45894	7.77
28mm	5	45895	7.77

T62/T062 Tap connector
push-fit x BSP union nut
Spigot and washer joint

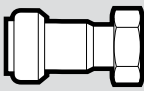

SIZE	BOX QTY	CODE	£ EACH
10mm x 1/2"	10	45900	4.35
15mm x 1/2"	10	45902	3.49
15mm x 3/4"	10	45171	4.76
22mm x 3/4"	5	45903	3.67

T62S Tap connector
male end for insertion into fitting x BSP union nut
Spigot and washer joint
Supplied with copper tail

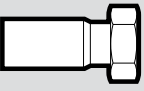

SIZE	BOX QTY	CODE	£ EACH
15mm x 1/2"	10	45910	3.32
15mm x 3/4"	10	45912	3.81
22mm x 3/4"	5	45914	3.84

T63/T063 Bent tap connector
push-fit x BSP union nut
Spigot and washer joint

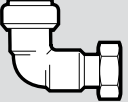

SIZE	BOX QTY	CODE	£ EACH
10mm x 1/2"	10	45920	6.96
15mm x 1/2"	10	45922	5.89
15mm x 3/4"	5	45923	12.94
22mm x 3/4"	5	45924	7.16

T68FF Flat faced union adaptor
push-fit x BSP union nut
Suitable for use with water meters

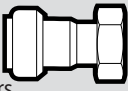

SIZE	BOX QTY	CODE	£ EACH
15mm x 3/4"	10	40759	4.34

Tectite bib tap kit
tap kit



SIZE	BOX QTY	CODE	£ EACH
	1	45070	44.76

Tectite Classic Flexifit

TF90 Flexible connector
Push-fit x push-fit
300mm long



SIZE	BOX QTY	CODE	£ EACH
15mm	1	45983	11.51
22mm	1	45984	17.23

TF92 Flexible tap connector
push-fit x BSP parallel female thread
Spigot and washer joint
300mm long



SIZE	BOX QTY	CODE	£ EACH
15mm x 1/2"	1	45985	9.57
22mm x 3/4"	1	45986	17.31

Tectite Classic push-fit manifolds

TM80 Manifold
push-fit x male end for insertion into fitting x push-fit outlet

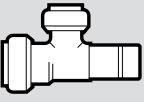

SIZE	BOX QTY	CODE	£ EACH
22 x 22 x 10mm	2	45940	7.69

TM81 Manifold
push-fit x male end for insertion into fitting x 2 push-fit outlets

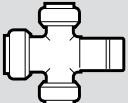

SIZE	BOX QTY	CODE	£ EACH
22 x 22 x 10 x 10mm	2	45942	14.20

Tectite Pro push-fit fittings

TX1/TX270 Straight coupling
push-fit x push-fit

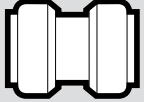

SIZE	BOX QTY	CODE	£ EACH
15mm	10	65114	2.92
22mm	5	65121	4.78
28mm	5	65123	9.97
35mm	1	45126	19.52
42mm	1	45128	24.40
54mm	1	45130	36.83

TX1 Slip/TX270S Straight coupling, slip pattern
push-fit x push-fit

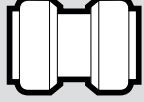

SIZE	BOX QTY	CODE	£ EACH
15mm	10	65141	3.65
22mm	5	65143	5.84
28mm	5	65144	11.98
35mm	1	45145	26.25
42mm	1	45146	32.03
54mm	1	45147	46.85

TX2/TX270G Straight female connector
push-fit x BSP parallel female thread

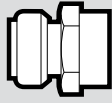

SIZE	BOX QTY	CODE	£ EACH
15mm x 1/2"	10	65206	5.94
22mm x 3/4"	5	65222	6.90
22mm x 1"	5	65223	9.05
28mm x 1"	2	65225	16.16
35mm x 1 1/4"	1	45230	22.19
42mm x 1 1/2"	1	45232	29.93
54mm x 2"	1	45234	46.94

TX3/TX243G Straight male connector
push-fit x BSP taper male thread

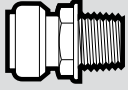

SIZE	BOX QTY	CODE	£ EACH
15mm x 1/2"	10	65267	3.80
22mm x 3/4"	5	65292	9.14
22mm x 1"	5	65294	9.74
28mm x 1"	2	65296	12.88
35mm x 1 1/4"	1	45310	17.74
42mm x 1 1/2"	1	45312	28.05
54mm x 2"	1	45314	35.77

TX3P/TX243G Straight male connector
push fit x BSP parallel male thread

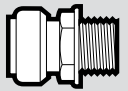

SIZE	BOX QTY	CODE	£ EACH
15mm x 1/2"	10	65358	3.80
22mm x 3/4"	5	65366	9.14
22mm x 1"	5	65368	9.74
28mm x 1"	2	65370	12.88



Tectite Pro push-fit fittings (contd)

TX6/TX243 Reducer
Larger end male for insertion into fitting x push-fit

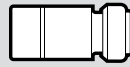

SIZE	BOX QTY	CODE	£ EACH
22 x 15mm	5	65426	4.04
28 x 15mm	5	65435	8.88
28 x 22mm	5	65438	7.75
35 x 15mm	1	45450	15.28
35 x 22mm	1	45452	14.96
35 x 28mm	1	45454	14.46
42 x 15mm	1	45456	22.29
42 x 22mm	1	45458	23.66
42 x 28mm	1	45460	22.94
42 x 35mm	1	45462	20.70
54 x 15mm	1	45464	46.23
54 x 22mm	1	45466	45.35
54 x 28mm	1	45468	40.00
54 x 35mm	1	45470	38.82
54 x 42mm	1	45472	34.06

TX12/TX090 Elbow
push-fit x push-fit

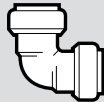

SIZE	BOX QTY	CODE	£ EACH
15mm	10	65516	3.42
22mm	5	65524	5.42
28mm	5	65526	13.54
35mm	1	45530	25.25
42mm	1	45532	32.86
54mm	1	45534	56.03

TX12S/TX092 Street elbow
push-fit x male copper for insertion into fitting

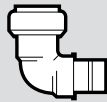

SIZE	BOX QTY	CODE	£ EACH
15mm	10	65496	3.60
22mm	5	65500	5.11
28mm	5	65502	13.19

TX13/TX092G Male elbow
push-fit x BSP taper male thread



SIZE	BOX QTY	CODE	£ EACH
15mm x 1/2"	10	65561	5.04
22mm x 3/4"	5	65576	6.18
28mm x 1"	5	65578	11.56

TX14/TX090G Female elbow
push-fit x BSP parallel female thread



SIZE	BOX QTY	CODE	£ EACH
15mm x 1/2"	10	65606	5.94
22mm x 3/4"	5	65620	9.05
28mm x 1"	2	65622	16.51

TX15/TX471G Backplate elbow
push-fit x BSP parallel female thread

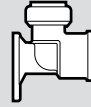

SIZE	BOX QTY	CODE	£ EACH
15mm x 1/2"	5	65646	9.51

TX21/TX041 Obtuse elbow
push-fit x push-fit



SIZE	BOX QTY	CODE	£ EACH
15mm	10	65535	4.07
22mm	5	65538	5.34
28mm	5	65539	18.55
35mm	1	45540	24.71
42mm	1	45541	28.54
54mm	1	45558	49.85

TX21S/TX040 Obtuse street elbow
push-fit x male end for insertion into fitting



SIZE	BOX QTY	CODE	£ EACH
15mm	10	65542	3.42
22mm	5	65545	4.84
28mm	5	65546	19.30
35mm	1	45547	25.97
42mm	1	45548	28.61
54mm	1	45549	52.28

TX24/TX130 Equal tee
Push-fit on all ends

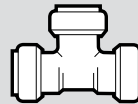

SIZE	BOX QTY	CODE	£ EACH
15mm	10	65666	5.04
22mm	5	65676	7.91
28mm	2	65678	17.67
35mm	1	45680	32.79
42mm	1	45682	49.72
54mm	1	45684	83.40

TX25/TX130 Tee, reduced branch
Push-fit on all ends

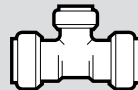

SIZE	BOX QTY	CODE	£ EACH
22 x 22 x 15mm	5	65737	7.03
28 x 28 x 15mm	2	65744	16.61
28 x 28 x 22mm	2	65746	16.61
35 x 35 x 15mm	1	45750	32.61
35 x 35 x 22mm	1	45752	32.61
35 x 35 x 28mm	1	45753	32.61
42 x 42 x 15mm	1	45754	50.10
42 x 42 x 22mm	1	45756	50.10
42 x 42 x 28mm	1	45758	50.10
54 x 54 x 15mm	1	45760	88.24
54 x 54 x 22mm	1	45762	88.24
54 x 54 x 28mm	1	45764	88.24
54 x 54 x 35mm	1	45765	104.58

TX26/TX130 Tee, one end reduced
Push-fit on all ends

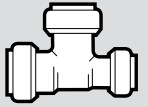

SIZE	BOX QTY	CODE	£ EACH
22 x 15 x 22mm	5	65786	7.03
28 x 15 x 28mm	2	65790	16.61
28 x 22 x 28mm	2	65793	16.61

TX27/TX130 Tee, one end and branch reduced
Push-fit on all ends

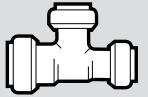

SIZE	BOX QTY	CODE	£ EACH
22 x 15 x 15mm	5	65820	7.03
28 x 22 x 22mm	2	65822	16.61

TX30/TX130G Female branch tee
push-fit ends x BSP parallel female branch

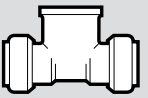

SIZE	BOX QTY	CODE	£ EACH
15 x 15mm x 1/2"	10	65840	9.74
22 x 22mm x 1/2"	5	65845	11.46
35 x 35mm x 1/2"	1	45848	39.11
42 x 42mm x 1/2"	1	45850	60.73

TX61/TX301 Stop end
Push-fit ends for use on tube

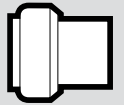

SIZE	BOX QTY	CODE	£ EACH
15mm	10	65866	2.69
22mm	5	65874	4.05
28mm	5	65876	9.13
35mm	1	45878	10.55
42mm	1	45880	11.80
54mm	1	45882	13.77

TX61RV/TX302 Air release stop end
push-fit x air release valve



SIZE	BOX QTY	CODE	£ EACH
15mm	10	65892	4.68
22mm	5	65894	8.91
28mm	5	65895	9.13

TX62/TX062 Tap connector
push-fit x BSP union nut Spigot and washer joint

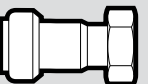

SIZE	BOX QTY	CODE	£ EACH
15mm x 1/2"	10	65902	3.94
15mm x 3/4"	10	65171	5.35
22mm x 3/4"	5	65903	4.27

TX63/TX063 Bent tap connector
push-fit x BSP union nut Spigot and washer joint

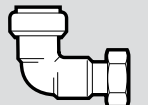

SIZE	BOX QTY	CODE	£ EACH
15mm x 1/2"	10	65922	6.60
22mm x 3/4"	5	65924	8.24

Tectite Pro push-fit fittings (contd)

TX68FF/TX068
Flat faced union adaptor
push-fit x BSP union nut
Suitable for use with water meters

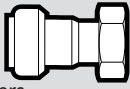

SIZE	BOX QTY	CODE	£ EACH
15mm x 3/4"	10	65759	4.91
22mm x 3/4"	5	65760	6.51

TX68S
Cylinder union
male end for insertion into
fitting x BSP union nut

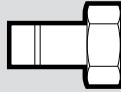

SIZE	BOX QTY	CODE	£ EACH
22mm x 1"	5	65930	3.46

Tectite Pro Flexifit

TXF90
Flexible connector
push-fit x push-fit
300mm long



SIZE	BOX QTY	CODE	£ EACH
15mm	1	65983	18.42
22mm	1	65984	27.56

TXF92
Flexible tap connector
Push-fix x BSP parallel
female thread
Spigot and washer joint
300mm long

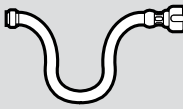

SIZE	BOX QTY	CODE	£ EACH
15mm x 1/2"	1	65985	15.40
22mm x 3/4"	1	65986	22.98

Tectite 316 System Tube

SS610
Stainless steel
316 System tube
6 metre lengths



SIZE	BOX QTY	CODE	£ MTR
15mm x 0.6mm	6	25010	Refer to XPress price list
18mm x 0.6mm	6	25012	
22mm x 0.6mm	6	25014	
28mm x 0.8mm	6	25016	
35mm x 1.0mm	6	25018	
42mm x 1.0mm	6	25020	
54mm x 1.0mm	6	25022	

Tectite 316 push-fit fittings

TS1/TS270
Straight coupling
push-fit x push-fit

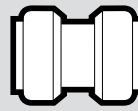

SIZE	BOX QTY	CODE	£ EACH
15mm	10	25114	5.05
18mm	5	25118	5.50
22mm	5	25121	6.39
28mm	5	25123	7.35
35mm	1	25126	9.01
42mm	1	25128	12.30
54mm	1	25130	19.60

TS1S/TS270S
Slip coupling
push-fit x push-fit

SIZE	BOX QTY	CODE	£ EACH
15mm	10	25141	6.31
18mm	5	25142	6.88
22mm	5	25143	7.99
28mm	5	25144	10.66

TS2/TS270G
Straight female connector
push-fit x BSP parallel
female thread

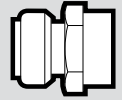

SIZE	BOX QTY	CODE	£ EACH
15mm x 1/2"	10	25206	10.37
18mm x 1/2"	5	25210	11.06
18mm x 3/4"	5	25212	11.51
22mm x 1/2"	5	25220	11.73
22mm x 3/4"	5	25222	13.82
22mm x 1"	5	25223	15.61
28mm x 3/4"	2	25224	19.11
28mm x 1"	2	25225	21.83
35mm x 1 1/4"	1	25230	23.57
42mm x 1 1/2"	1	25232	36.30
54mm x 2"	1	25234	54.24

TS3/TS243G
Straight male connector
push-fit x BSP taper
male thread

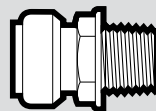

SIZE	BOX QTY	CODE	£ EACH
15mm x 1/2"	10	25267	9.63
18mm x 1/2"	5	25286	10.72
18mm x 3/4"	5	25288	10.62
22mm x 1/2"	5	25290	12.04
22mm x 3/4"	5	25292	12.04
28mm x 3/4"	2	25295	16.61
28mm x 1"	2	25296	15.51
35mm x 1 1/4"	1	25310	22.46
42mm x 1 1/2"	1	25312	32.75
54mm x 2"	1	25314	43.96

TS6/TS243
Reducer
Larger end male for insertion
into fitting x push-fit

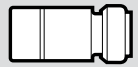

SIZE	BOX QTY	CODE	£ EACH
18 x 15mm	5	25424	5.50
22 x 15mm	5	25426	6.07
22 x 18mm	5	25430	6.29
28 x 15mm	5	25435	6.98
28 x 18mm	5	25437	7.11
28 x 22mm	5	25438	7.20
35 x 22mm	1	25452	8.69
35 x 28mm	1	25454	10.78
42 x 22mm	1	25458	28.64
42 x 28mm	1	25460	29.00
42 x 35mm	1	25462	29.30
54 x 35mm	1	25470	33.61
54 x 42mm	1	25472	34.44

TS12/TS090
Elbow
push-fit x push-fit



SIZE	BOX QTY	CODE	£ EACH
15mm	10	25516	7.22
18mm	5	25520	8.37
22mm	5	25524	8.54
28mm	5	25528	13.04
35mm	1	25530	20.29
42mm	1	25532	33.85
54mm	1	25534	46.77

TS12S/TS092
Street elbow
push-fit x male end for
insertion into fitting

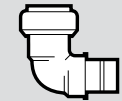

SIZE	BOX QTY	CODE	£ EACH
15mm	10	25496	7.07
18mm	5	25498	8.15
22mm	5	25500	9.87
28mm	5	25502	12.55

TS13/TS092G
Male elbow
push-fit x BSP taper
male thread

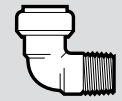

SIZE	BOX QTY	CODE	£ EACH
15mm x 1/2"	10	25561	13.27
18mm x 1/2"	5	25569	14.45
22mm x 3/4"	5	25576	18.35
28mm x 1"	5	25578	23.85

TS14/TS090G
Female elbow
push-fit x BSP parallel
female thread



SIZE	BOX QTY	CODE	£ EACH
15mm x 1/2"	10	25606	15.15
18mm x 1/2"	5	25614	17.44
18mm x 3/4"	5	25615	17.44
22mm x 3/4"	5	25620	20.45
28mm x 1"	2	25622	27.04



Tectite 316 push-fit fittings (contd)

TS15/TS471G
Backplate elbow
push-fit x BSP parallel
female thread

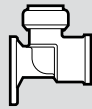

SIZE	BOX QTY	CODE	£ EACH
15mm x 1/2"	5	25646	16.99
18mm x 1/2"	5	25650	18.09
22mm x 3/4"	5	25654	26.29

TS18/TS002A
Slow bend
push-fit x push-fit

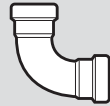

SIZE	BOX QTY	CODE	£ EACH
15mm	5	26003	17.34
18mm	5	26005	19.59
22mm	5	26007	20.17
28mm	5	26008	22.03
35mm	1	26009	38.63
42mm	1	26010	65.88
54mm	1	26011	98.21

TS18S/TS001
Slow street elbow
push-fit x male end for
insertion into fitting

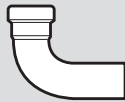

SIZE	BOX QTY	CODE	£ EACH
15mm	5	26023	16.89
18mm	5	26025	19.10
22mm	5	26027	19.66
28mm	5	26028	21.47

TS21/TS041
Obtuse elbow
push-fit x push-fit



SIZE	BOX QTY	CODE	£ EACH
15mm	10	26043	9.83
18mm	5	26045	10.61
22mm	5	26047	12.26
28mm	5	26048	14.53
35mm	1	26049	16.84
42mm	1	26050	27.10
54mm	1	26051	35.22

TS21S/TS040
Obtuse street elbow
push-fit x male end for
insertion into fitting



SIZE	BOX QTY	CODE	£ EACH
15mm	10	26063	9.63
18mm	5	26065	10.35
22mm	5	26067	11.83
28mm	5	26068	14.15
35mm	1	26069	15.90
42mm	1	26070	25.64
54mm	1	26071	33.37

TS24/TS130
Equal tee
push-fit on all ends

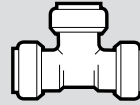

SIZE	BOX QTY	CODE	£ EACH
15mm	10	25666	11.83
18mm	5	25670	13.72
22mm	5	25676	14.57
28mm	2	25678	17.41
35mm	1	25680	21.77
42mm	1	25682	30.89
54mm	1	25684	45.37

TS25/TS130
Tee, reduced branch
push-fit on all ends

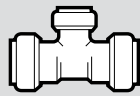

SIZE	BOX QTY	CODE	£ EACH
18 x 18 x 15mm	5	25725	11.84
22 x 22 x 15mm	5	25737	12.52
22 x 22 x 18mm	2	25742	12.92
28 x 28 x 15mm	2	25744	15.44
28 x 28 x 18mm	2	25745	15.81
28 x 28 x 22mm	2	25746	16.66
35 x 35 x 15mm	1	25750	18.83
35 x 35 x 22mm	1	25752	19.59
35 x 35 x 28mm	1	25753	20.44
42 x 42 x 22mm	1	25756	28.05
42 x 42 x 28mm	1	25758	29.00
54 x 54 x 22mm	1	25762	46.45
54 x 54 x 28mm	1	25764	46.45
54 x 54 x 35mm	1	25765	51.27
54 x 54 x 42mm	1	25766	51.27

TS30/TS130G
Female branch tee
push-fit ends x BSP parallel
female branch

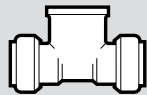

SIZE	BOX QTY	CODE	£ EACH
15 x 15mm x 1/2"	10	25840	12.95
18 x 18mm x 1/2"	5	25843	13.22
22 x 22mm x 1/2"	5	25845	14.29
22 x 22mm x 3/4"	5	25846	15.97
28 x 28mm x 1/2"	2	25847	16.02
35 x 35mm x 1/2"	1	25848	23.39
42 x 42mm x 1/2"	1	25850	31.73

TS61/TS301
Stop end
push-fit end for use on
stainless steel tube

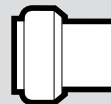

SIZE	BOX QTY	CODE	£ EACH
15mm	10	25866	4.82
18mm	5	25870	5.09
22mm	5	25874	5.61
28mm	5	25876	8.10
35mm	1	25878	9.26
42mm	1	25880	12.97
54mm	1	25882	15.03

TS62/TS062
Tap connector
push-fit x BSP union nut
Spigot and washer joint

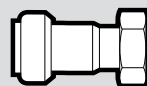

SIZE	BOX QTY	CODE	£ EACH
15mm x 1/2"	10	25902	9.83
22mm x 3/4"	5	25903	14.84

Carbon Steel System Tube

SC640
Galvanised Carbon Steel System Tube
3 and 6 metre lengths

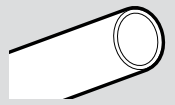

SIZE	BOX QTY	CODE	£ MTR
15mm x 1.2mm	3	45080	Refer to XPress price list
18mm x 1.2mm	3	45081	
22mm x 1.5mm	3	45082	
28mm x 1.5mm	3	45083	
35mm x 1.5mm	3	45084	
42mm x 1.5mm	3	45085	
54mm x 1.5mm	3	45086	

SIZE	BOX QTY	CODE	£ MTR
15mm x 1.2mm	6	25080	Refer to XPress price list
18mm x 1.2mm	6	25081	
22mm x 1.5mm	6	25082	
28mm x 1.5mm	6	25083	
35mm x 1.5mm	6	25084	
42mm x 1.5mm	6	25085	
54mm x 1.5mm	6	25086	

SC660
Plastic Coated Galvanised Carbon Steel System Tube
6 metre lengths
Wall thickness dimensions include plastic coating of 1mm thickness on all sizes

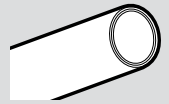

SIZE	BOX QTY	CODE	£ MTR
15mm x 2.2mm	6	25060	Refer to XPress price list
18mm x 2.2mm	6	25061	
22mm x 2.5mm	6	25062	
28mm x 2.5mm	6	25063	
35mm x 2.5mm	6	25064	
42mm x 2.5mm	6	25065	
54mm x 2.5mm	6	25066	

Tectite Advance push-fit fittings

TA1/TA270
Straight coupling
push-fit x push-fit

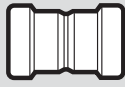

SIZE	BOX QTY	CODE	£ EACH
15mm	10	76000	1.28
18mm	10	76001	1.35
22mm	5	76002	1.54
28mm	5	76003	1.97
35mm	5	76004	3.28
42mm	1	76005	4.39
54mm	1	76006	5.17

TA12/TA090
Elbow
push-fit x push-fit



SIZE	BOX QTY	CODE	£ EACH
15mm	10	76033	1.85
18mm	10	76034	2.15
22mm	5	76035	2.42
28mm	5	76036	3.32
35mm	5	76037	8.29
42mm	1	76038	13.27
54mm	1	76039	15.85

TA215/TA040
Obtuse street elbow
push-fit x male end for
insertion into fitting



SIZE	BOX QTY	CODE	£ EACH
15mm	10	76054	2.01
18mm	10	76055	2.06
22mm	5	76056	2.20
28mm	5	76057	3.34
35mm	5	76058	6.05
42mm	1	76059	8.08
54mm	1	76060	9.21

TA2/TA270G
Straight female connector
push-fit x BSP parallel
female thread

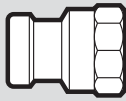

SIZE	BOX QTY	CODE	£ EACH
15mm x 1/2"	10	76007	3.98
18mm x 1/2"	10	76008	4.01
18mm x 3/4"	10	76009	4.85
22mm x 3/4"	5	76010	4.76
28mm x 1"	5	76011	6.05
35mm x 1 1/4"	1	76151	8.14
42mm x 1 1/2"	1	76152	2.85

TA12S/TA092
Street elbow
push-fit x male end for
insertion into fitting



SIZE	BOX QTY	CODE	£ EACH
15mm	10	76040	1.85
18mm	10	76041	2.15
22mm	5	76042	2.42
28mm	5	76043	3.32
35mm	5	76044	8.29
42mm	1	76045	13.27
54mm	1	76046	15.85

TA24/TA130
Equal tee
Push-fit on all ends

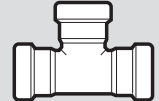

SIZE	BOX QTY	CODE	£ EACH
15mm	10	76061	3.54
18mm	10	76062	3.81
22mm	5	76063	4.08
28mm	2	76064	5.47
35mm	5	76065	8.53
42mm	1	76066	12.59
54mm	1	76067	15.10

TA3/TA243G
Straight male connector
push-fit x BSP taper
male thread

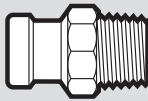

SIZE	BOX QTY	CODE	£ EACH
15mm x 1/2"	10	76013	3.98
15mm x 3/8"	10	76012	4.08
18mm x 1/2"	10	76014	4.11
18mm x 3/4"	10	76015	5.00
22mm x 3/4"	5	76016	4.76
28mm x 1"	5	76017	6.05
35mm x 1 1/4"	5	76018	7.75
42mm x 1 1/2"	1	76019	8.65
54mm x 2"	1	76020	13.43

TA13/TA092G
Male elbow
push-fit x BSP taper
male thread



SIZE	BOX QTY	CODE	£ EACH
15mm x 1/2"	10	76153	2.85
18mm x 1/2"	10	76139	3.72
22mm x 3/4"	5	76140	4.33

TA25/TA130
Tee, reduced branch
Push-fit on all ends

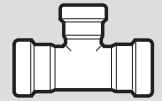

SIZE	BOX QTY	CODE	£ EACH
18 x 18 x 15mm	10	76068	3.81
22 x 22 x 15mm	5	76069	4.01
22 x 22 x 18mm	5	76070	4.08
28 x 28 x 15mm	2	76071	5.42
28 x 28 x 18mm	2	76072	5.62
28 x 28 x 22mm	2	76073	5.89
35 x 35 x 15mm	5	76074	7.96
35 x 35 x 18mm	5	76075	8.44
35 x 35 x 22mm	5	76076	8.58
35 x 35 x 28mm	5	76077	8.70
42 x 42 x 22mm	1	76078	11.49
42 x 42 x 28mm	1	76079	11.92
42 x 42 x 35mm	1	76080	11.65
54 x 54 x 22mm	1	76081	13.71
54 x 54 x 28mm	1	76082	13.97
54 x 54 x 35mm	1	76083	14.38
54 x 54 x 42mm	1	76084	15.08

TA6/TA243
Reducer
Larger end male for insertion
into fitting x push-fit

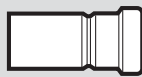

SIZE	BOX QTY	CODE	£ EACH
18 x 15mm	10	76021	1.18
22 x 15mm	5	76022	1.18
22 x 18mm	5	76023	1.27
28 x 15mm	5	76024	1.54
28 x 18mm	5	76025	1.54
28 x 22mm	5	76026	1.63
35 x 15mm	5	76110	1.72
35 x 18mm	5	76111	1.76
35 x 22mm	5	76027	1.82
35 x 28mm	5	76028	1.94
42 x 22mm	1	76112	3.88
42 x 28mm	1	76113	3.30
42 x 35mm	1	76029	4.20
54 x 22mm	1	76030	12.14
54 x 35mm	1	76114	12.50
54 x 28mm	1	76031	12.22
54 x 42mm	1	76032	12.85

TA21/TA041
Obtuse elbow
push-fit x push-fit

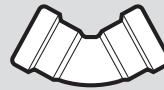

SIZE	BOX QTY	CODE	£ EACH
15mm	10	76047	2.20
18mm	10	76048	2.32
22mm	5	76049	2.44
28mm	5	76050	3.34
35mm	5	76051	6.57
42mm	1	76052	8.25
54mm	1	76053	9.31

TA30/TA130G
Female branch tee
push-fit ends x BSP
parallel female branch



SIZE	BOX QTY	CODE	£ EACH
15 x 15mm x 1/2"	10	76085	5.05
18 x 18mm x 1/2"	10	76086	5.05
22 x 22mm x 1/2"	5	76087	5.55
28 x 28mm x 1/2"	2	76088	6.45
35 x 35mm x 1/2"	5	76089	8.81
42 x 42mm x 1/2"	1	76090	13.71
54 x 54mm x 1/2"	1	76091	15.08

**Tectite Advance
push-fit fittings (contd)**

TS61/TS301

Stop end
push-fit end for use on
stainless steel tube

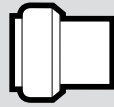

SIZE	BOX QTY	CODE	£ EACH
15mm	10	25866	Refer to Tectite 316 prices
18mm	5	25870	
22mm	5	25874	
28mm	5	25876	
35mm	1	25878	
42mm	1	25880	
54mm	1	25882	

TA69/TA331G
**Straight male
union connector**

push-fit x BSP taper male thread

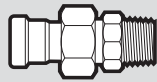

SIZE	BOX QTY	CODE	£ EACH
15mm x 1/2"	10	76092	10.57
18mm x 1/2"	10	76094	13.39
22mm x 3/4"	5	76097	15.62
28mm x 1"	2	76099	17.36
35mm x 1 1/4"	5	76100	24.70
42mm x 1 1/2"	1	76101	36.54
54mm x 2"	1	76102	46.75

Tectite Accessories

DT/305
Disconnecting tool



SIZE	BOX QTY	CODE	£ EACH
10mm	1	45970	4.53
12mm	1	45971	4.53
15mm	1	45973	4.53
18mm	1	45975	4.53
22mm	1	45977	4.53
28mm	1	45978	5.04

DC/405
Disconnecting clip



SIZE	BOX QTY	CODE	£ EACH
10mm	5	46100	1.37
12mm	5	46101	1.37
15mm	5	46103	1.37
18mm	5	46105	1.37
22mm	5	46107	1.37
28mm	2	46108	1.76

DTX/305
Disconnecting tool



SIZE	BOX QTY	CODE	£ EACH
35-54mm	1	46145	20.36

T66
PEX liner
For insertion into tube

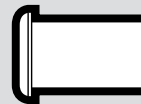

SIZE	BOX QTY	CODE	£ EACH
10mm	20	60100	0.25
15mm	50	60103	0.28
22mm	50	60105	0.32
28mm	20	60106	0.49

T67
Copper liner
For insertion into tube

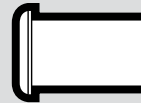

SIZE	BOX QTY	CODE	£ EACH
10mm	20	60144	11.09

T110 Multipurpose tool
Deburring/Depth gauge/Scribe,
For use with Tectite Classic,
Tectite Pro & 316 upto 28mm

SIZE	BOX QTY	CODE	£ EACH
10-28mm	1	46132	21.09

T115 Multipurpose tool
Deburring/Depth gauge/Scribe,
For use with Tectite Sprint

SIZE	BOX QTY	CODE	£ EACH
10-28mm	1	75640	3.28

T117
Depth Gauge

For use with Tectite Advance

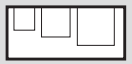

SIZE	BOX QTY	CODE	£ EACH
15mm	10	76120	3.48

T120
Pipe clips-nail in
Bag of 50



SIZE	BOX QTY	CODE	£ EACH
10mm	50	60110	0.08
15mm	100	60111	0.23
22mm	100	60112	0.23
28mm	50	60113	0.26

T125
Bend former

For use with PEX pipe



SIZE	BOX QTY	CODE	£ EACH
15mm	10	60130	1.54

T140
Pipe cutter-ratchet
For use with PEX pipe



SIZE	BOX QTY	CODE	£ EACH
10-28mm	1	60120	21.99

TCX
End cap

SIZE	BOX QTY	CODE	£ EACH
35mm	1	46180	2.29
42mm	1	46181	3.24
54mm	1	46182	4.08

TDX
Demounting end cap

SIZE	BOX QTY	CODE	£ EACH
35mm	1	46146	3.84
42mm	1	46151	5.55
54mm	1	46156	7.73

TX100
Replacement 'O' ring

SIZE	BOX QTY	CODE	£ EACH
35mm	5	46147	0.48
42mm	5	46148	0.66
54mm	5	46149	0.86

Tectite Accessories (contd)

TX105/405
Replacement grab ring
For Tectite Pro

SIZE	BOX QTY	CODE	£ EACH
35mm	5	46135	0.70
42mm	5	46136	1.13
54mm	5	46137	1.13

TS106
Replacement grab ring
For Tectite 316

SIZE	BOX QTY	CODE	£ EACH
35mm	5	46183	1.26
42mm	5	46184	2.00
54mm	5	46185	2.55

S120
Deburring Tool

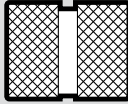

SIZE	BOX QTY	CODE	£ EACH
15mm - 54mm	1	39168	Refer to XPress price list

S122
Tube preparation kit

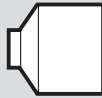

SIZE	BOX QTY	CODE	£ EACH
35 - 54mm	1	39233	Refer to XPress price list

S130
Silicone lubricant grease



SIZE	BOX QTY	CODE	£ EACH
100g tub	1	39219	Refer to XPress price list

Tectite Pro Valves

TX480
Servicing valve
push-fit x push-fit



SIZE	BOX QTY	CODE	£ EACH
15mm	10	65950	9.15

TX481
Servicing valve
push-fit x BSP union nut
Spigot and washer joint



SIZE	BOX QTY	CODE	£ EACH
10mm x 1/2"	10	45952	8.35
15mm x 1/2"	10	65954	7.77

TX490L/TX457
Quarter-turn ball valve
push-fit x push-fit

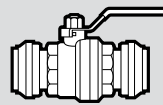

SIZE	BOX QTY	CODE	£ EACH
15mm	2	65962	Refer to Pegler price list
22mm	2	65964	Refer to Pegler price list

TX495
Quarter turn ball valve
with flat face union connector
and draining tap push-fit
x BSP union nut

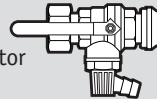

SIZE	BOX QTY	CODE	£ EACH
15mm x 3/4"	2	65960	17.31

TX496
Quarter-turn ball valve
with flat face union connector
push-fit x BSP union nut

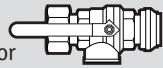

SIZE	BOX QTY	CODE	£ EACH
15mm x 3/4"	2	65959	14.98

TX526S/TX467
DZR draining tap
Male end for insertion into fitting
Draining tap to BS 2879 Type 2

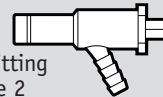

SIZE	BOX QTY	CODE	£ EACH
15mm	10	65936	5.94

Chrome plated			
15mm	10	65936CP	16.38



Pegler Yorkshire

Price List – 1st March 2010



Notes



Pegler Yorkshire

Price List – 1st March 2010



Notes

1. General

In these conditions, reference to the Company shall mean Pegler Yorkshire. All quotations are made and all orders are accepted subject to these conditions. All other terms, conditions or warranties whatsoever are excluded from the contract or any variation thereof unless expressly accepted by the Company in writing. In the event of a conflict between these conditions and the specific terms and conditions of quotation then the latter shall prevail.

2. Electronic Trading

- a) If the Company and Buyer agree that electronic trading between them shall be a basis for order processing and invoicing then the Standard Interchange Agreement (1st Edition March 1989) of the EDI Association shall be incorporated into the contract by reference subject to these conditions.
- b) Electronic orders shall be valid if all the information agreed between the Buyer and the Company as being required is properly set out in the agreed format and the order is transmitted by the Buyer to the Company by reference to the correct identification code and is received by the Company when collecting its electronic mail from the relevant system.
- c) Each valid electronic order will be deemed accepted by the Company unless the Company communicates rejection of the order to the Buyer by electronic or other means (including telephone) within 24 hours of receipt. Acceptance of an order shall constitute a contract for sale and purchase to which these conditions and the Standard Interchange Agreement shall prevail.
- d) If the Company and the Buyer agree that invoicing may be done by electronic mail, then payment will be due 30 days after the date of electronic invoice unless agreed otherwise.

3. Delivery

Any date for delivery named by the Company is an estimate only and in no circumstances shall the failure of the Company to deliver on or before the named date either entitle the Buyer to rescind or terminate the contract or make the Company liable in any way for the consequences of any delay.

4. Export

Unless specifically stated otherwise in these conditions all trade terms not specifically covered by these conditions shall be interpreted in accordance with INCOTERMS current on the date of that order.

5. Warranty and Defective Goods

- a) Save as otherwise provided by the other conditions of these Conditions, sections 12 to 15 of the Sale of Goods Act 1979 are to be implied into this contract.
- b) The goods delivered under the Contract shall, where the Contract includes a specification, comply with the specification or, if there is no specification, shall be of normal industrial quality.
- c) The Buyer does not rely on any statement or representations other than those which have been made in writing by the Company.
- d) The Buyer must give the Company immediate written notice of any defect in the goods. Such goods shall be returned to the Company and if proved to have been defective at delivery as a result of faulty materials or workmanship, the Company shall at its option replace or repair such goods. Defects in quality or dimension in any delivery shall not be ground for cancellation of the remainder of the order.
- e) Save for any liability for death or personal injury caused by the Company's negligence, the Company's liability in connection with defective goods shall be limited to the repair or supply of a replacement for the defective goods, and the Company shall not be liable for any other loss or damage including, but not limited to loss of profit, labour costs, damage to property, wasted expenditure or cost of mitigation.

6. Data and Technical Information

The information contained in the advertising sales and technical literature issued by the Company may be relied upon to be accurate in the exact circumstances in which it is expressed. Any illustrations, performance details, examples of illustrations and methods of assembly and all other technical data in such literature are based on experience and upon trials under test conditions and are provided for general guidance only.

7. Claims For Damage, Shortage or Loss

No claim for damage in transit or shortage of delivery can be accepted unless, a separate notice in writing is given to

the carrier concerned and to the Company within three days of receipt of the goods, followed by a complete claim in writing within five days of receipt of the goods. No claim for loss of goods in transit can be accepted unless a separate notice in writing is given to the carrier concerned and to the Company, and a complete claim in writing made within 21 days of the date of consignment. Where goods are accepted from the carrier concerned without being checked, the delivery book of the carrier must be signed "not examined". If a complaint is not made to the Company as herein provided, the products shall be deemed to be in all respects in accordance with the Contract, and the Buyer shall be bound to pay for the same accordingly.

8. Suspension of Deliveries

- a) Deliveries may be wholly or partially suspended by the company in the event of:-
- Stoppage, delay or interruption caused to the business of the Company as a result of strikes, lockouts, trade disputes, breakdown, accident or any cause whatsoever beyond the reasonable control of the Company.
 - Any default by the Buyer in making payment of any amounts owed to the Company under this and any other contracts between them.
- b) In the event of any hostilities (whether war is declared or not) in which Great Britain is involved, or in the event of national emergency, or if the Company's works should become either directly or indirectly engaged on Government orders as to prevent or delay work on other orders, the Company shall be entitled at any time, on notice to the Buyer, to make partial deliveries only or to determine the contract without prejudice in any case to rights accrued in respect of deliveries already made.

9. Determination of Contract

The Company shall have the right forthwith to determine this and/or any other Contract between the Buyer and the Company by written notice to the Buyer's last known address (without prejudice to any claim or right the Company might otherwise make or exercise) in any of the following events:-

- If the Buyer shall make default in or commit a breach of any contract with the Company; or
- If any distress or execution shall be levied upon the Buyer's property or assets; or
- If the Buyer shall make or offer to make any arrangements or composition with creditors, or commit any act of bankruptcy or become insolvent; or
- If any petition or receiving order in bankruptcy shall be presented or made against him; or
- If the buyer shall be a limited Company and become subject of any resolution or petition for winding up or administration; or
- If a receiver or manager of the Buyer's undertaking, property or assets or any part thereof shall be appointed.

10. Indemnity

The Buyer will indemnify the Company against all damages, penalties, costs and expenses to which the Company may become liable as a result of work done to the Buyer's instructions or which infringe any letters, patent or registered design or copyright or any other third party intellectual property rights.

11. Prices

The price payable for the goods shall unless otherwise agreed be the Company's list price current at the date of despatch. Such prices are inclusive of delivery to the Buyer's UK mainland delivery point but costs of delivery to any other destinations will be charged to the Buyer.

12. Risk and Title

- a) Risk shall pass to the Buyer so that the Buyer is responsible for all loss, damage or deterioration to the goods:
- If the Company delivers the goods by its own transport at the time when the goods or a relevant part thereof arrive at the place of delivery; or
 - In all other circumstances at the time when the goods, or a relevant part thereof leave the premises of the Company whether or not the Company arranges transport and (without prejudice to clause 7) where the goods are delivered by carrier, any claims for loss or damage in transit must be made by the Buyer against the carrier in accordance with the carrier's conditions.
- b) Title to the goods supplied under the contract shall only pass to the Buyer when payment in full for all goods supplied under this and all other contracts between the Company and the Buyer has been received by the Company. The Company reserves the immediate right to possession of and at any time may recover all goods in respect of which

title has not passed to the Buyer; the Company is hereby authorised by the Buyer to enter upon any premises where such goods are held by or on behalf of the Buyer and recover possession thereof.

c) Until title to goods has been passed to the Buyer pursuant to these conditions it shall possess the goods as a Bailee at will of the Company, and the Buyer shall not be entitled to sell or otherwise deal in goods in respect of which title has not passed to the Buyer. If the Buyer acts in breach of these conditions then without prejudice to any other rights of the Company the Buyer shall have a fiduciary duty to account to the Company for the proceeds of any sale save to the extent that any such proceeds exceed the amounts owed to the Company under this and all other contracts between the Company and the Buyer.

13. Cancellation

Cancellation will only be accepted by the Company on condition that all costs and expenses incurred by the Company up to the time of cancellation and all loss of profits and other loss or damage suffered by the Company as a result of such cancellation will be paid forthwith by the Buyer to the Company.

14. Payment of Accounts

- a) Unless otherwise agreed by the Company in writing, payment shall be settled in full by the last working day of the month following the month in which the goods were despatched, or would have been despatched save for postponement otherwise than due to default on the part of the Company. The Company shall be entitled to submit its invoice on the same day as its delivery advice note or at any time thereafter, save that where delivery has been postponed at the request of or the default of the Buyer, then the Company may submit its invoice at any time after the goods are ready for delivery or would have been ready in the ordinary course but for the request or default as aforesaid.
- b) The Company reserves the right to charge interest at a rate up to 5% above Lloyds Bank Base Lending Rate ruling at the time payment is due if payment is not made in accordance with the terms agreed at the time the order is accepted.

15. VAT

The prices quoted are exclusive of VAT which will, if applicable, be added to the invoice at the rate then current.

16. Consumer Protection Act

In circumstances where the Company supplies parts or goods to the Buyer for incorporation with, or use ancillary to, any composite goods to be produced, manufactured, processed or supplied by the Buyer then:

- The Buyer shall forthwith on demand produce for inspection by the Company copies of all written instructions, information and warnings in relation to the said composite goods, provided nevertheless that such inspection or right to inspect shall not of itself constitute acceptance or approval on the part of the Company of such instructions, information, or warnings; and
- The Buyer shall indemnify, reimburse and compensate the Company for all losses and damages (including costs, expenses and charges for legal actions in which the Company may be involved) that the Company may incur in the event that any claim or claims are made against the Company pursuant to the Act relating to the said composite goods of the Buyer or parts or goods supplied hereunder in circumstances in which the parts or goods supplied by the Company was either:
 - Not the defective part of the said composite goods; or
 - Was only rendered the defective part or became defective goods by reason of actions or omission of the Buyer; or
 - Was only rendered the defective part or became defective goods by reason of instructions or warnings given or omitted by the Buyer or other supplier of the said composite goods supplied hereunder.

c) For the purposes of this condition the word "defective" shall be interpreted in accordance with the definition contained in the Act and this condition shall mutatis mutandis apply in relation to equivalent legislation of other states as it applies in relation to the Act.

17. Law and Jurisdiction

This contract shall be governed and construed according to the Law of England and the parties hereby agree to submit to the exclusive jurisdiction of the English courts.



Pegler Yorkshire

Our brands:

terrier

HEATING SOLUTIONS

YORKSHIRE

SOLDER RING SOLUTIONS

Tectite

PUSH-FIT SOLUTIONS

XPress

PRESS-FIT SOLUTIONS

ENDEX

END FEED SOLUTIONS

KUTERLITE

COMPRESSION SOLUTIONS

PRESTEX

DOMESTIC VALVE SOLUTIONS

PEGLER

COMMERCIAL VALVE SOLUTIONS

meibes

SOLAR PUMP SOLUTIONS

PERFORMA

UTILITY TAP SOLUTIONS

**francis
pegler**

LUXURY TAP SOLUTIONS

UK sales

Free Phone: 0800 156 0010

Free Fax: 0808 156 1011

Email: uk.sales@pegleryorkshire.co.uk

Export

Tel: +44 (0) 1302 855 656

Fax: +44 (0) 1302 730 513

Email: export@pegleryorkshire.co.uk

Technical Help

Free Phone: 0800 156 0050

Free Fax: 0808 156 1012

Email: tech.help@pegleryorkshire.co.uk

Brochure Hotline

Free Phone: 0800 156 0020

Free Fax: 0808 156 1011

Email: info@pegleryorkshire.co.uk

www.pegleryorkshire.co.uk

Pegler Yorkshire Group Limited

St. Catherine's Avenue, Doncaster,
South Yorkshire, DN4 8DF, England.

Tel: 0844 243 4400 Fax: 0844 243 9870

Registered in England Company No. 00401507

Registered Office: Haigh Park Road, Stourton, Leeds,
West Yorkshire, LS10 1RT, England.

All brand names and logo styles are registered trademarks.
Maintaining a policy of continual product development,
Pegler Yorkshire reserves the right to change specifications, design
and materials of products listed in this publication without prior notice.

LIT.REF: WEB ONLY